

N. te Rietmolen & B. Köpke

BILINGUAL APHASIA SCREENING TEST

(DUTCH VERSION)

STIMULUS BOOK

for

TWEETALIG AFASIE TEST

1 2 3 4 5

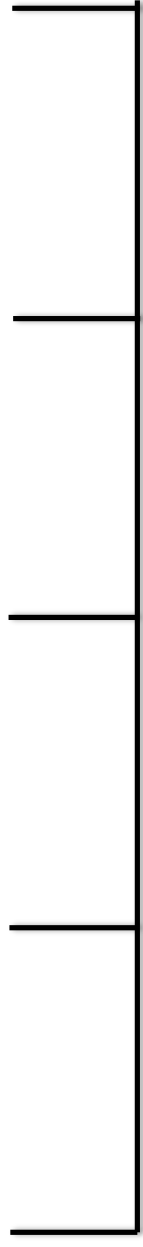

AUDITIVO-VERBAAL ONDERSCHIEDINGSVERMOGEN

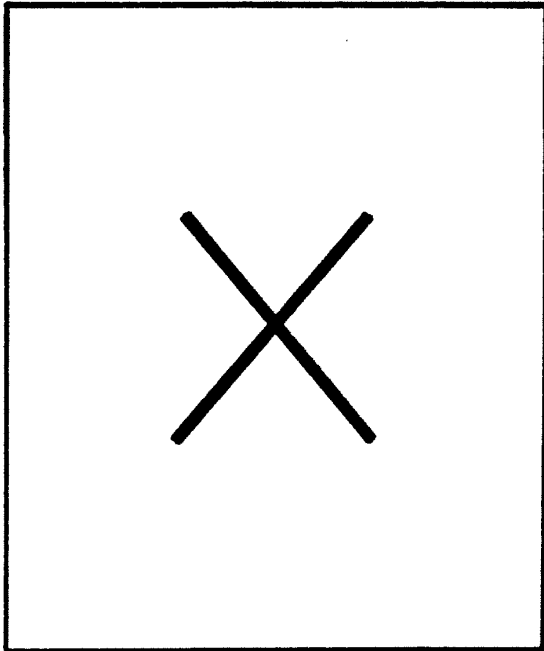

1

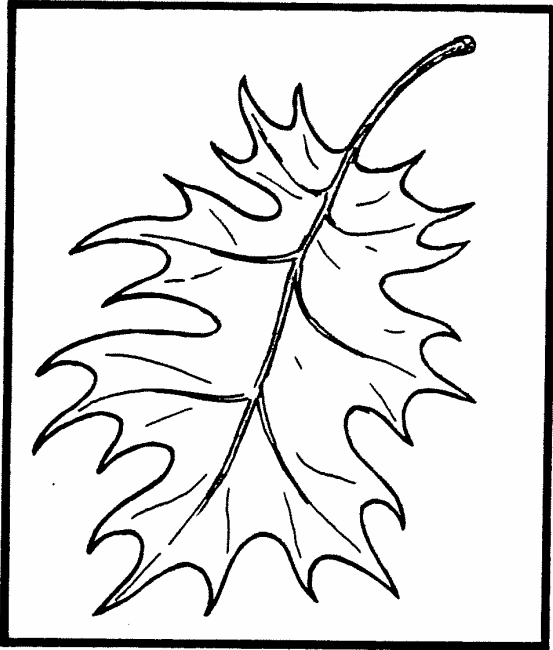

2

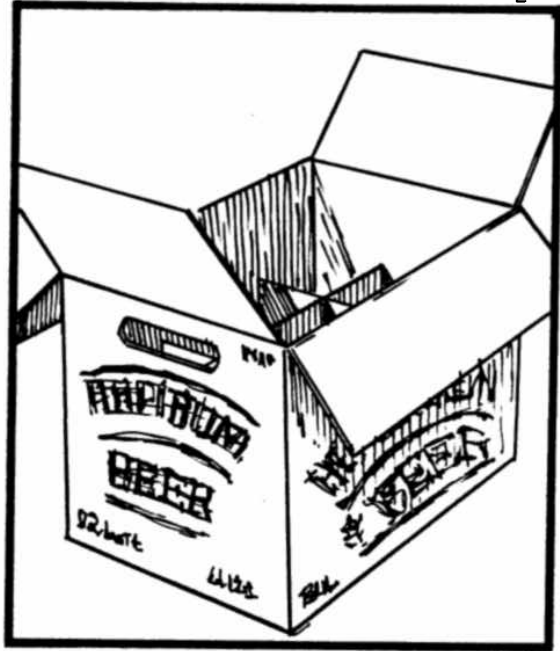

3

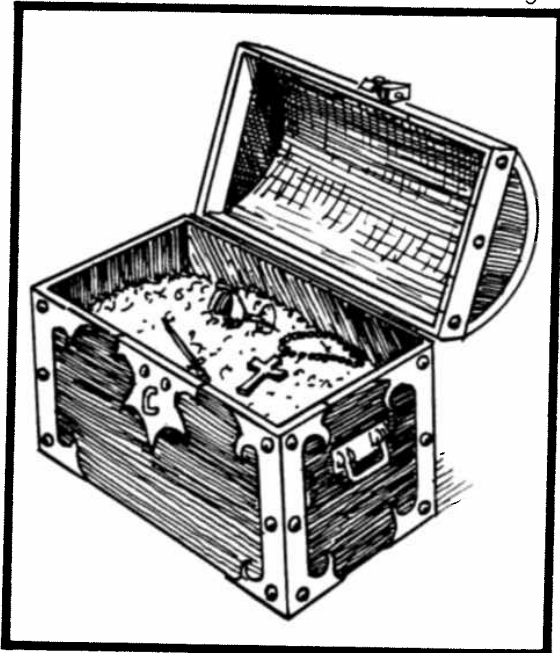

4

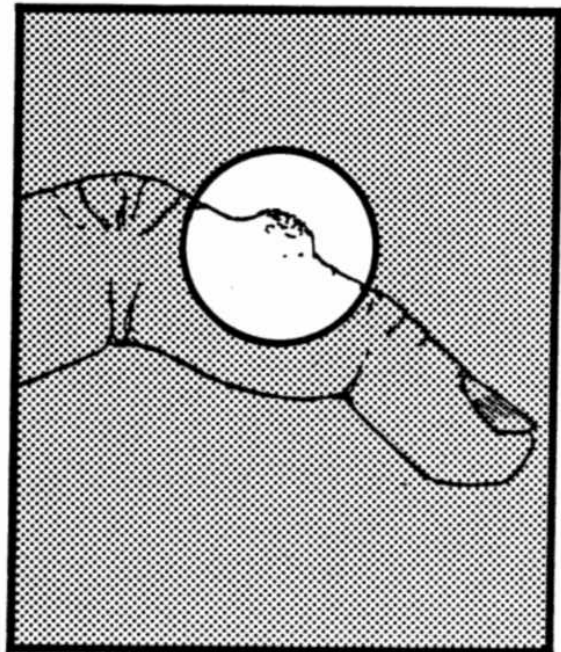

Voorbeeld

1

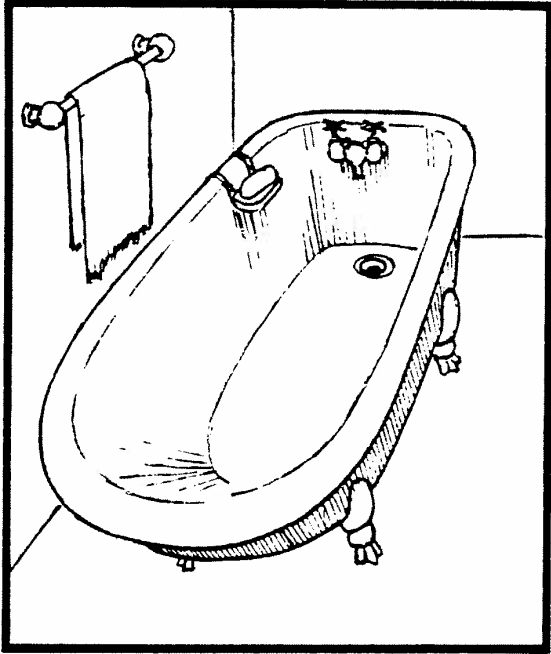

2



3

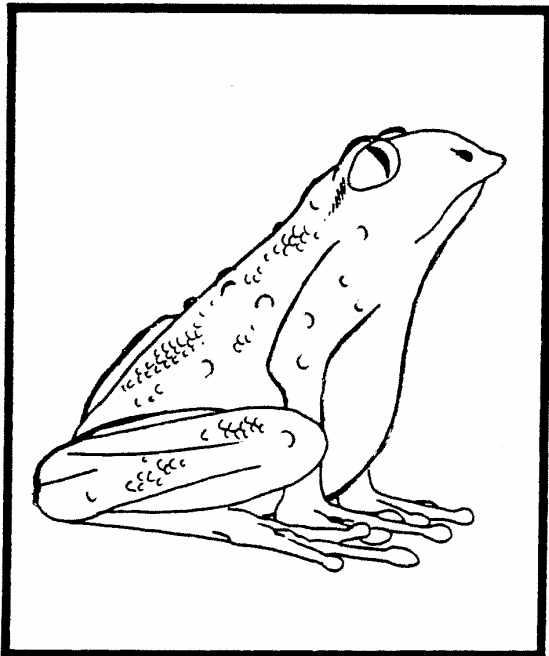

4

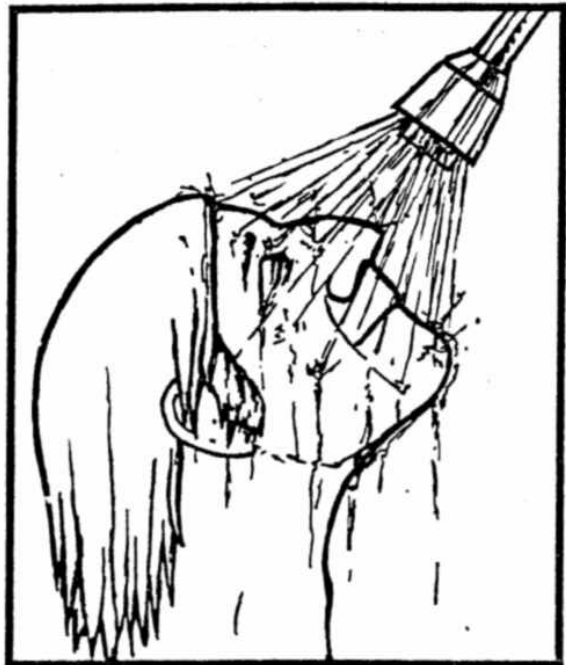

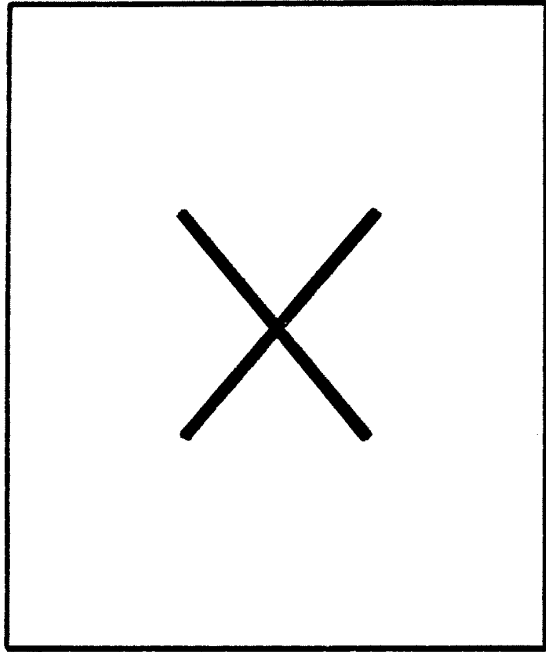

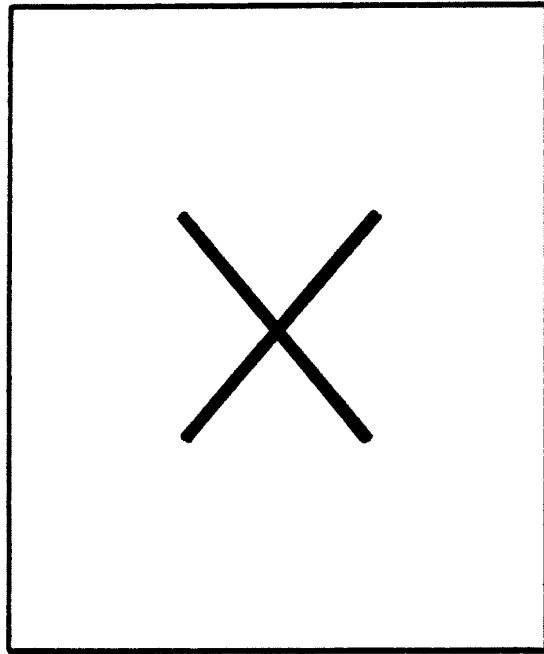

1

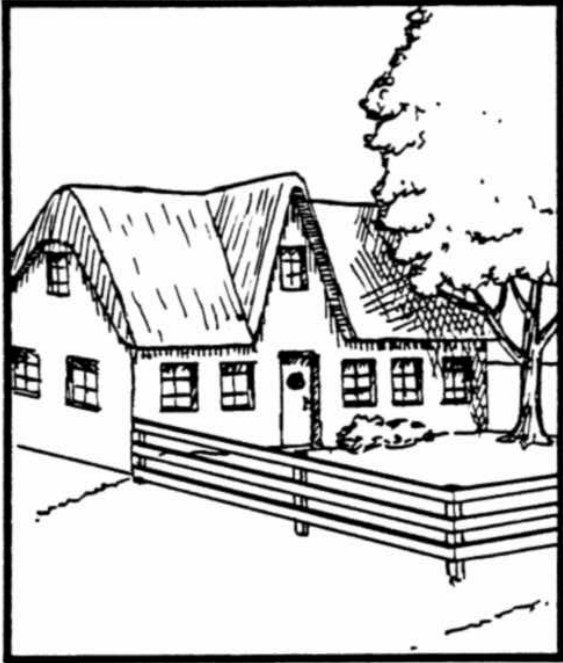

2

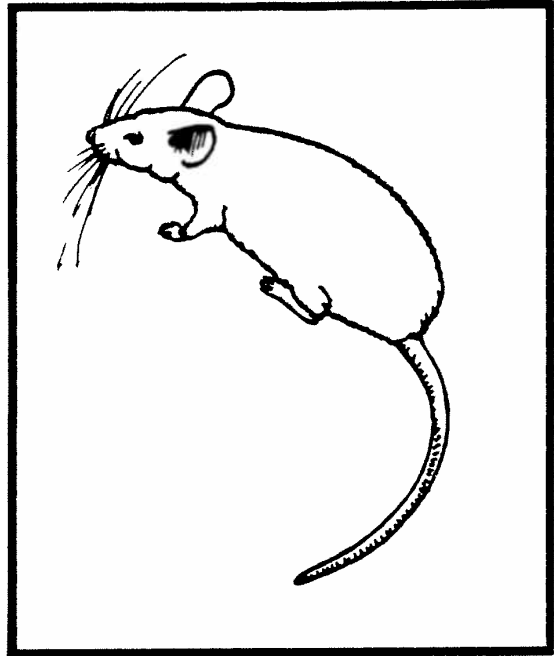

3

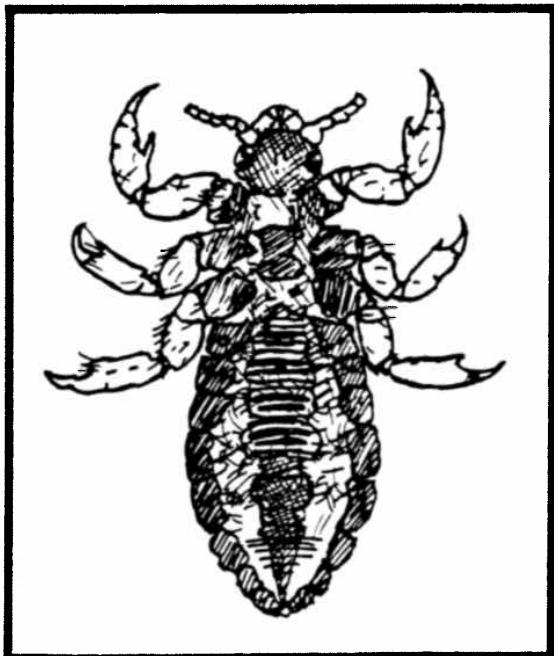

4

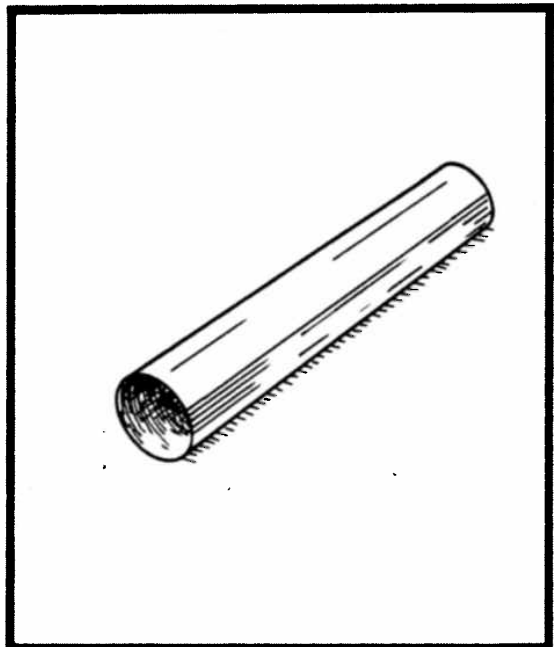

1

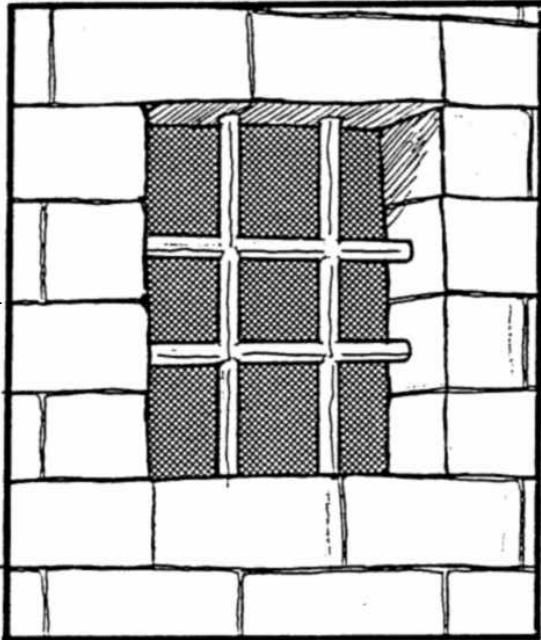

2

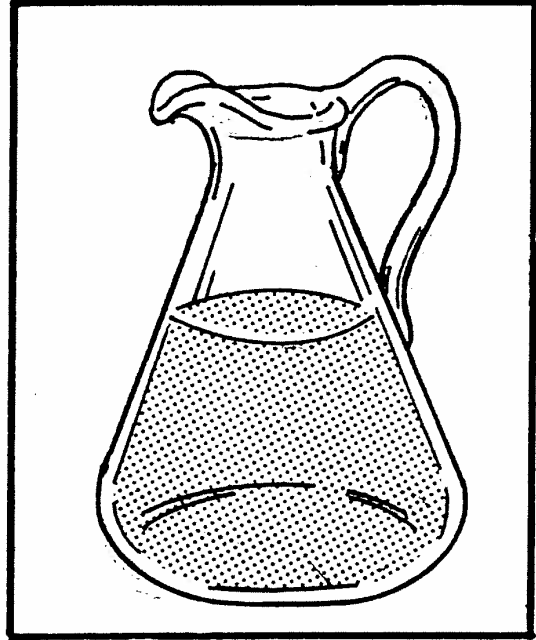

3

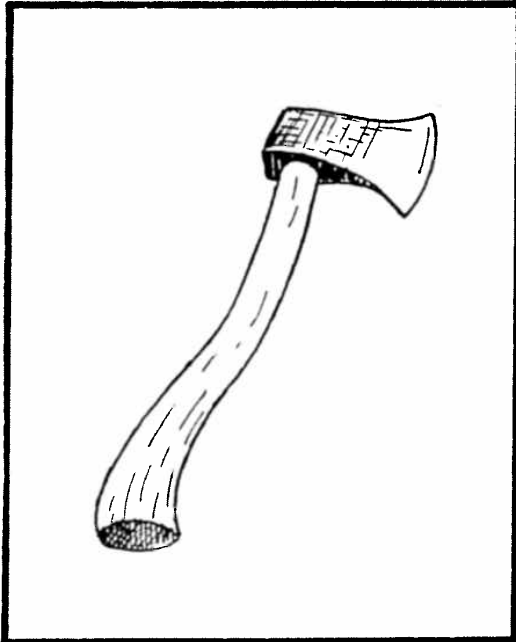

4

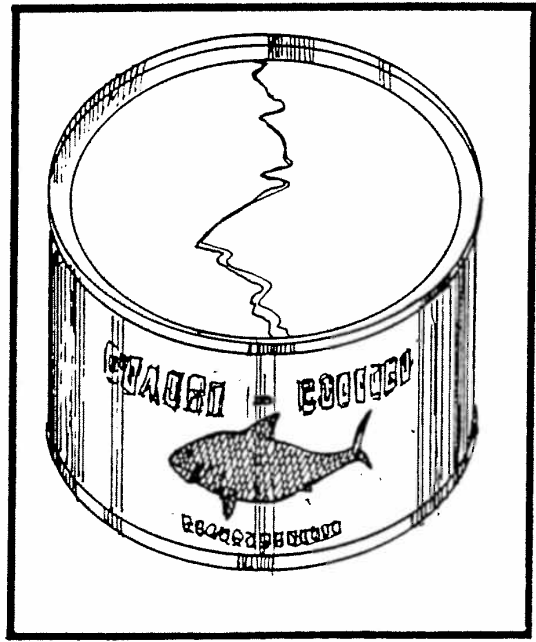

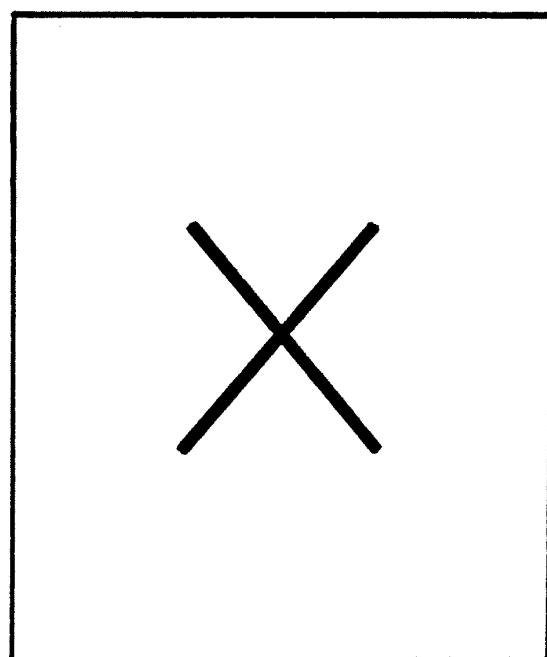

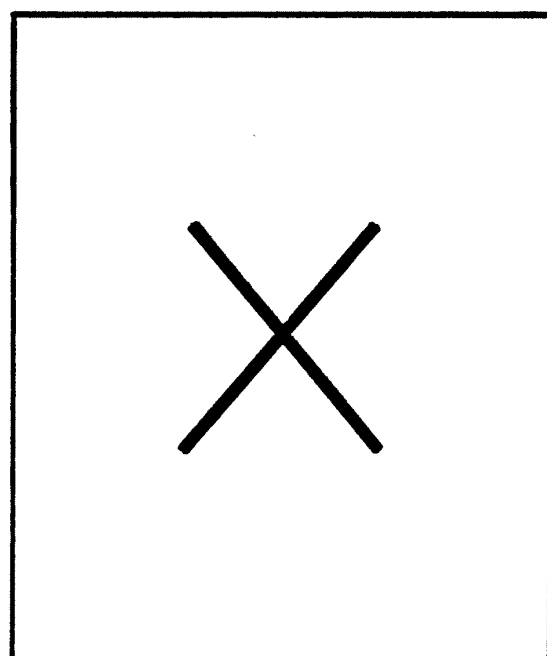

1

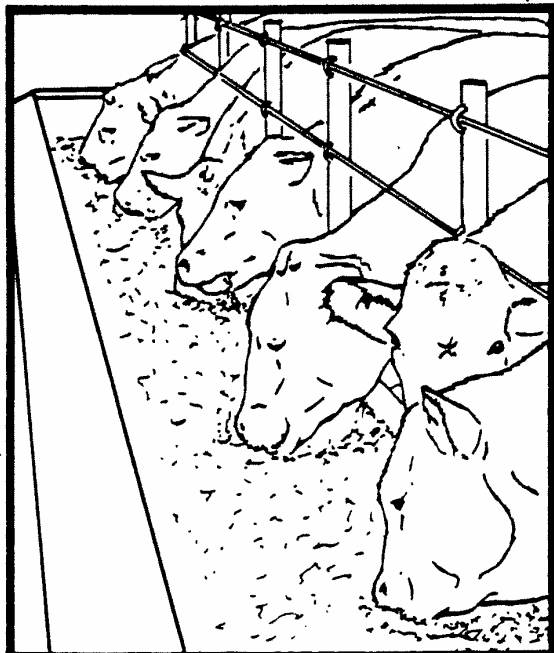

2



3

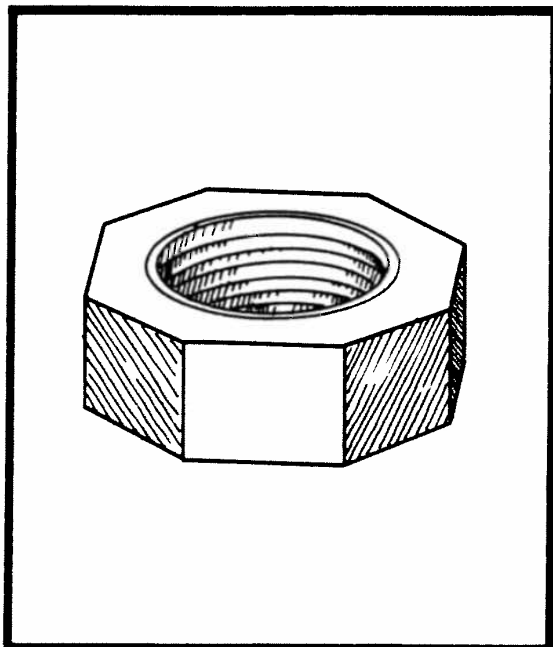

4

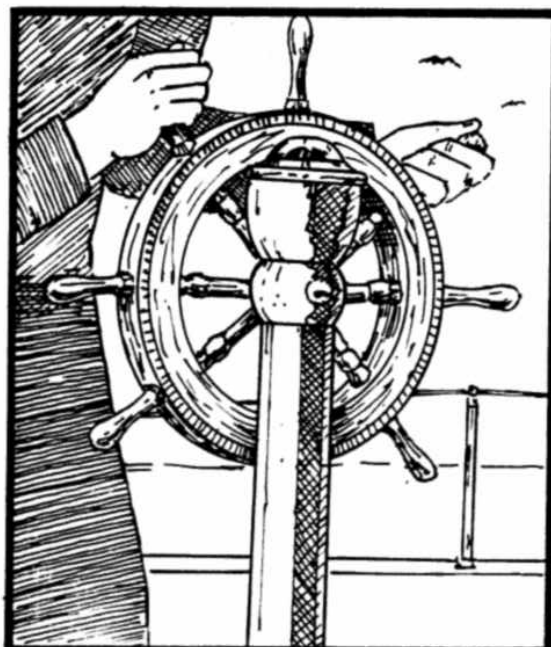

1

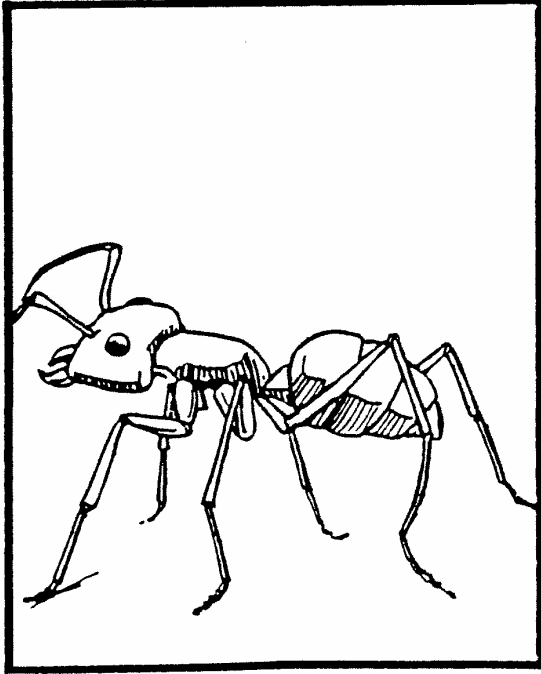

2

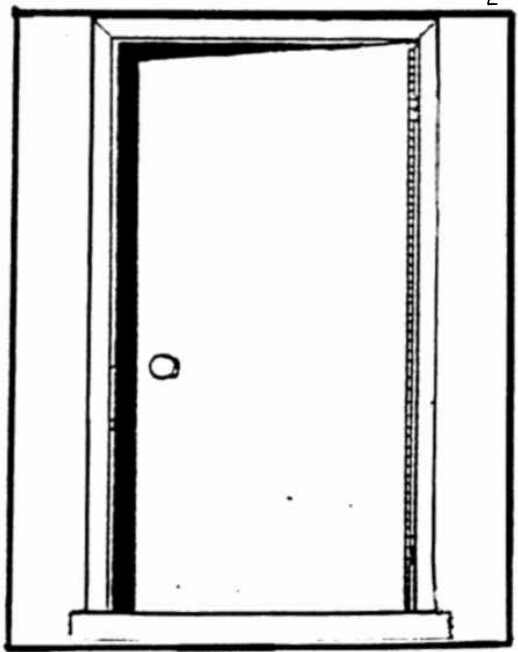

3

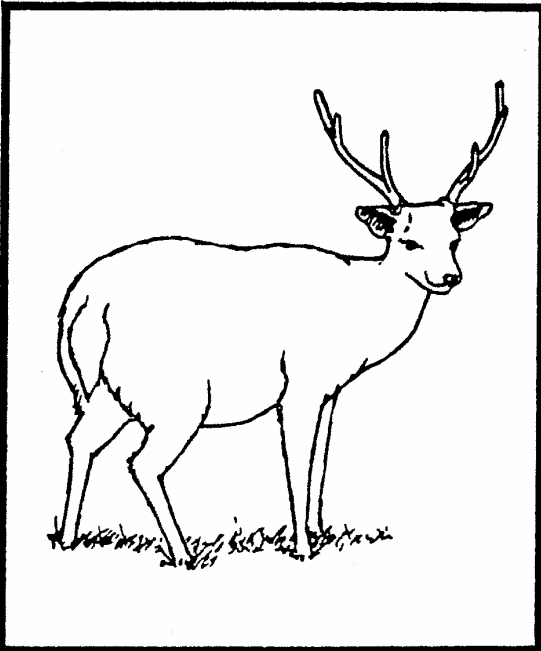

4

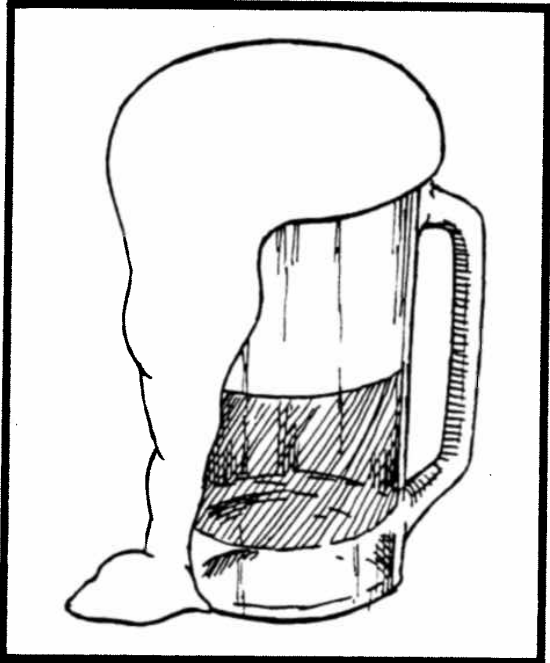

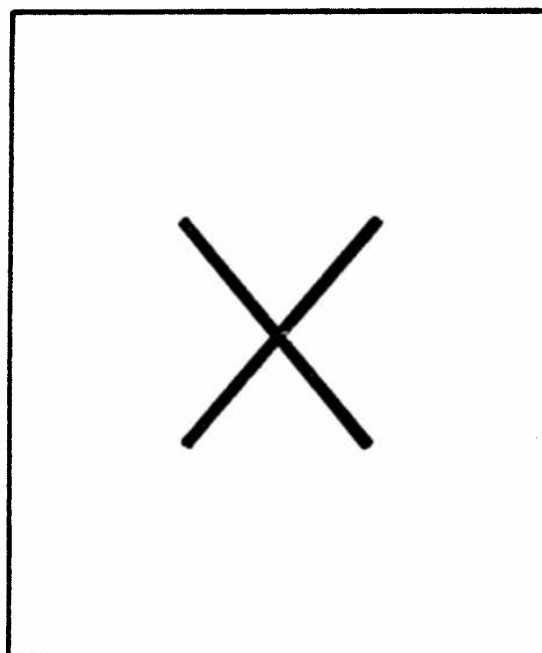

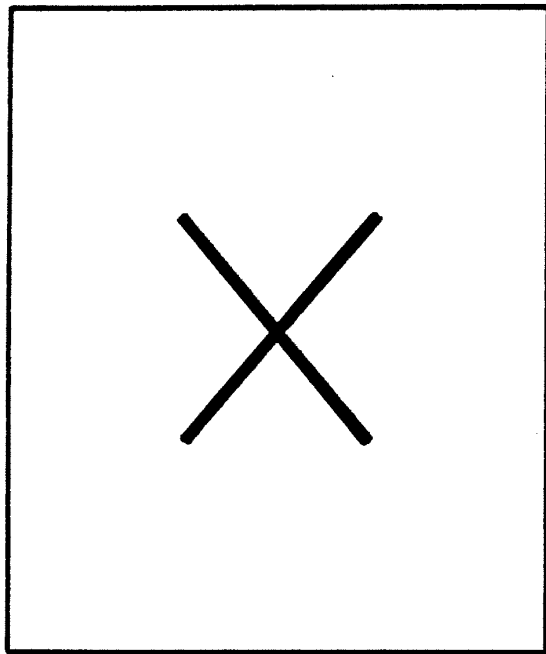

1

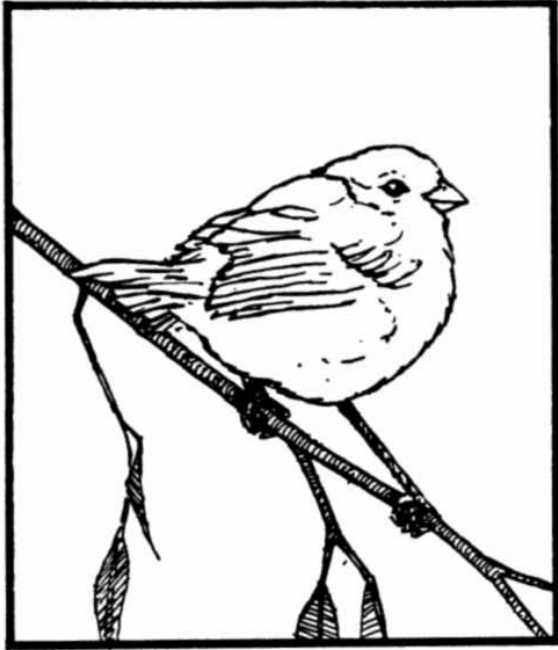

2

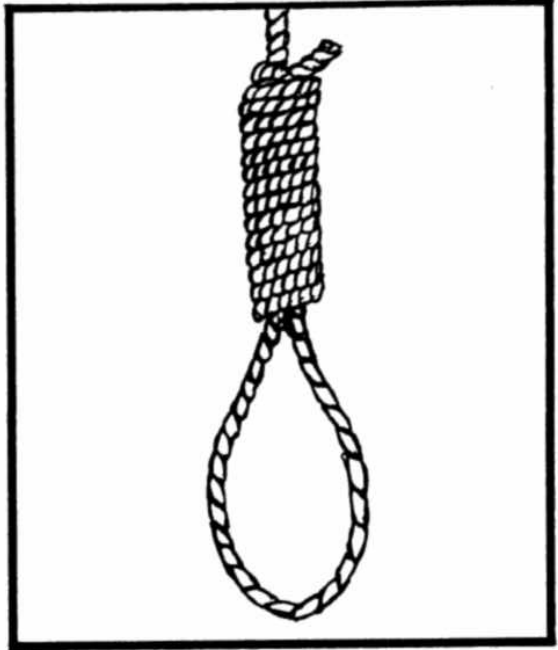

3



4

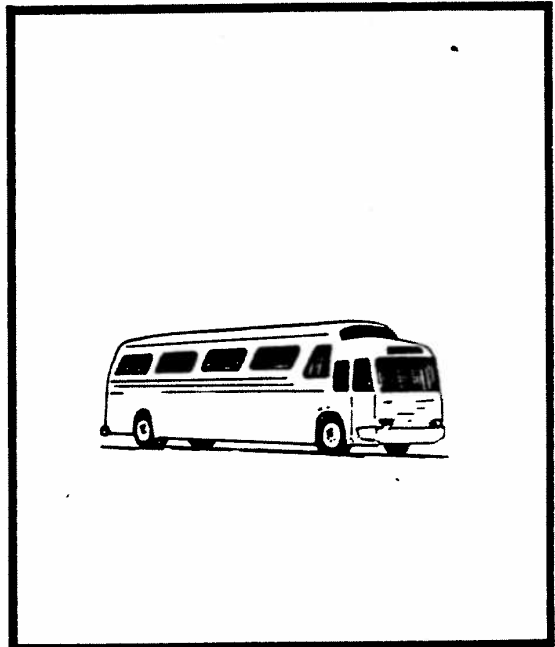

1

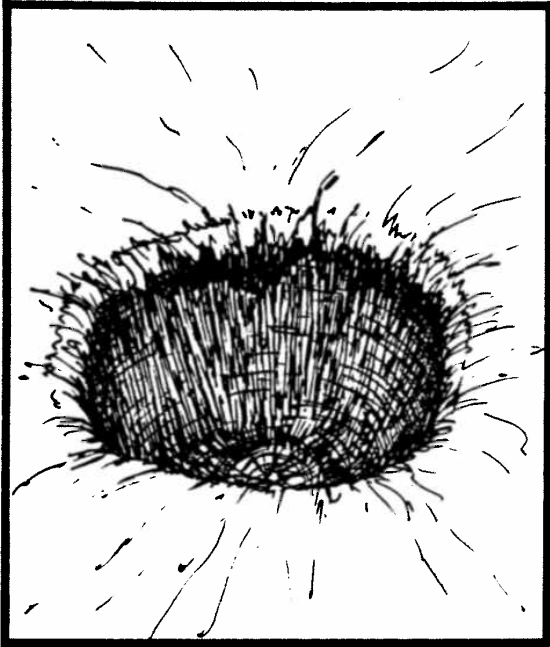

2

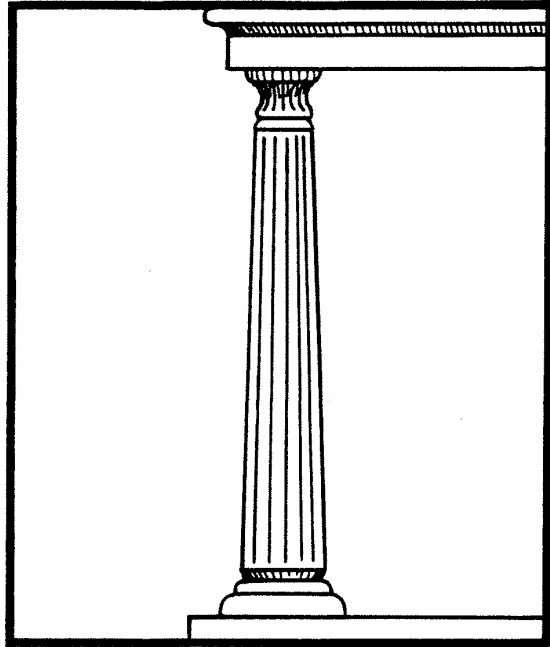

3

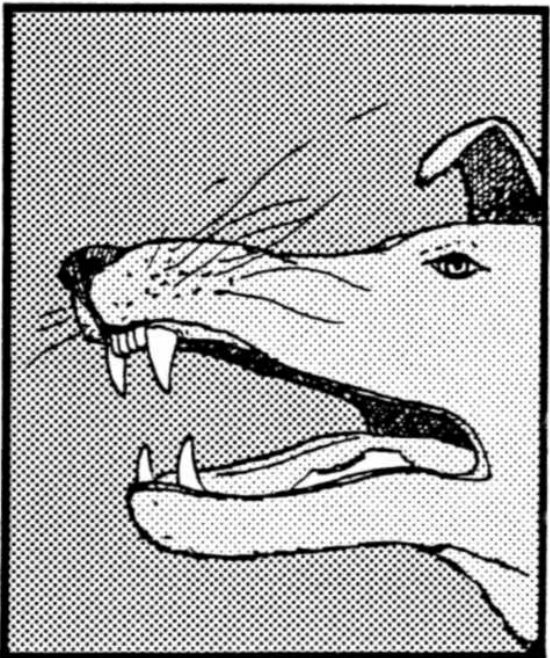

4

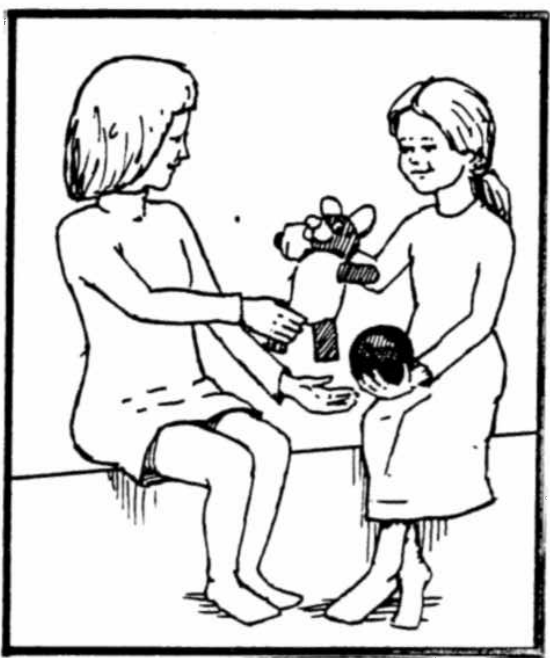

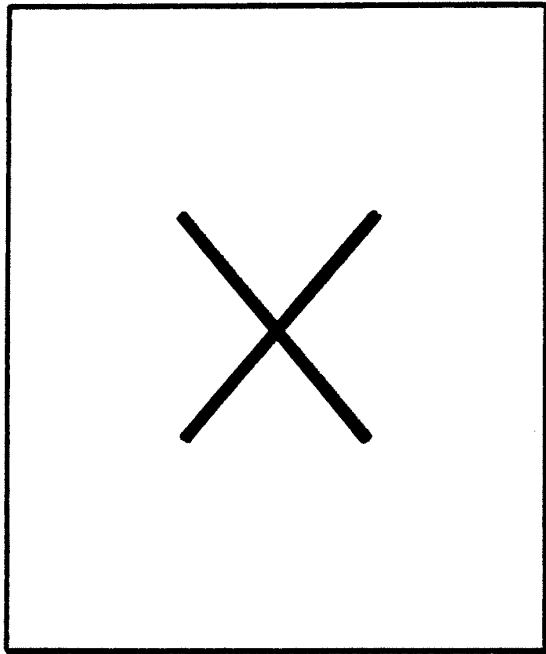

SYNTACTISCH BEGRIPSVERMOGEN

1

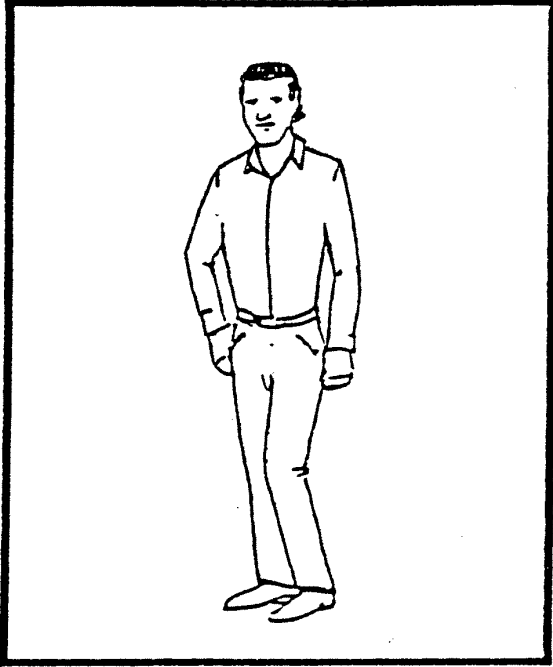

2

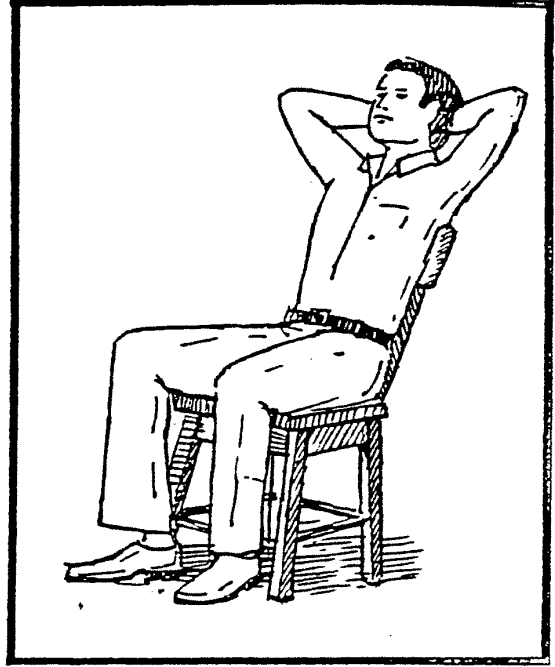

3

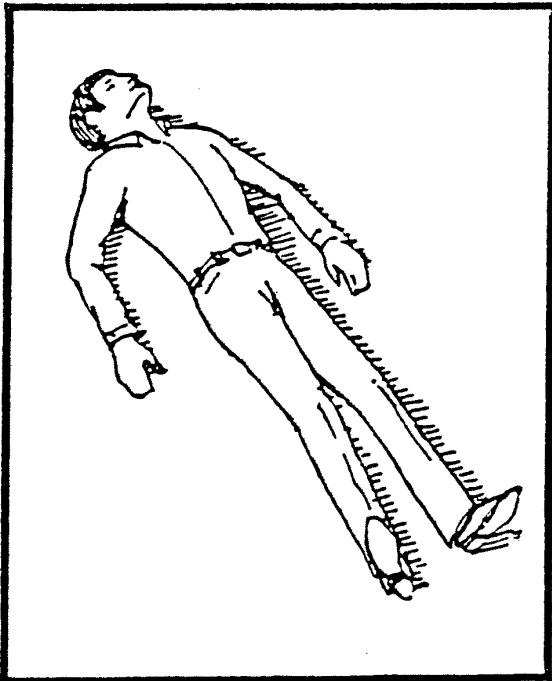

4

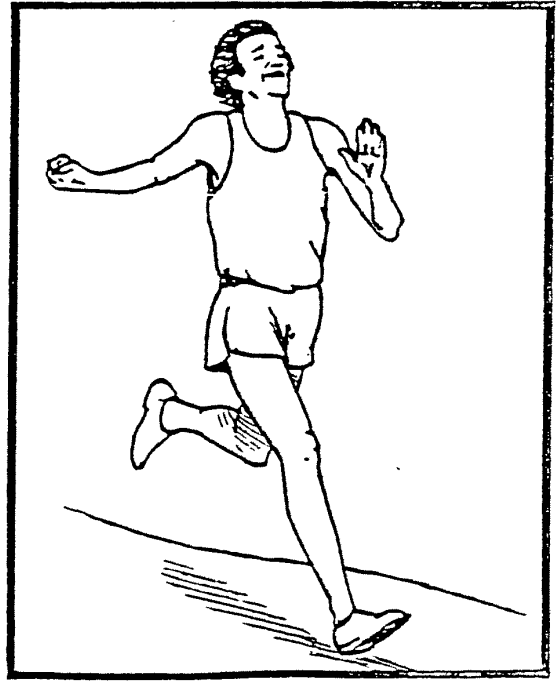

Voorbeeld

1

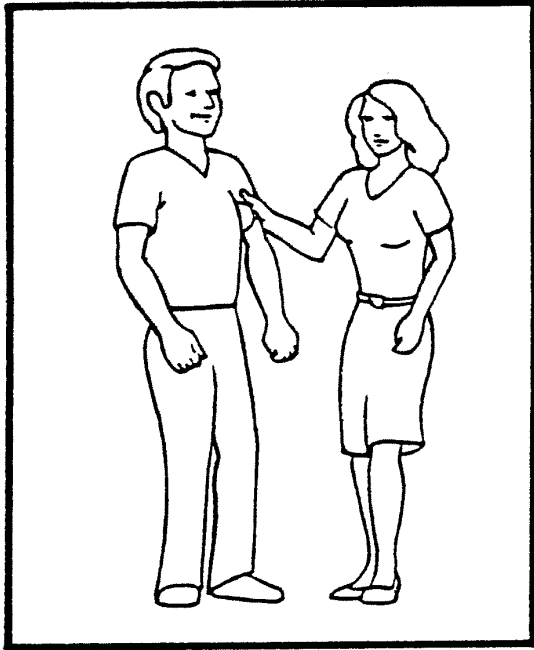

2

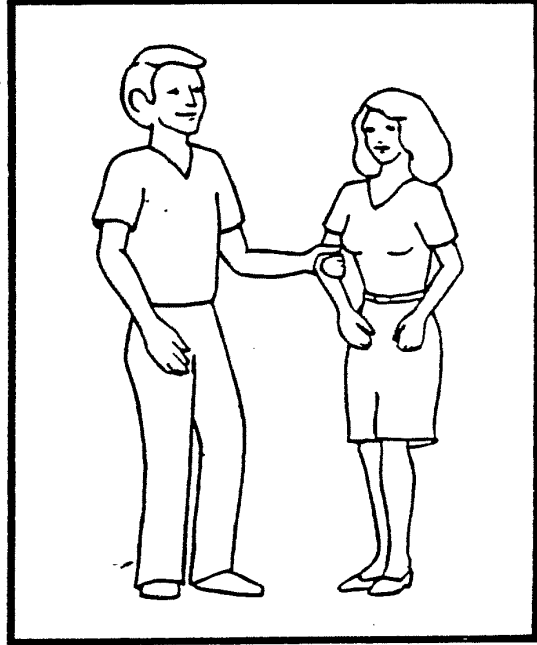

3

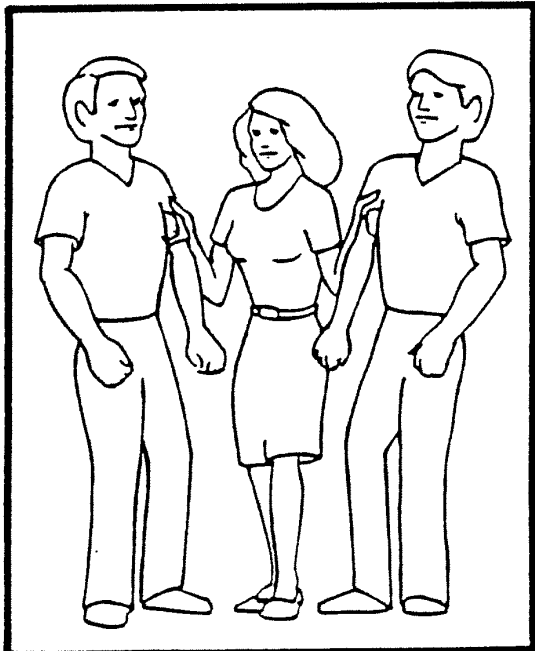

4

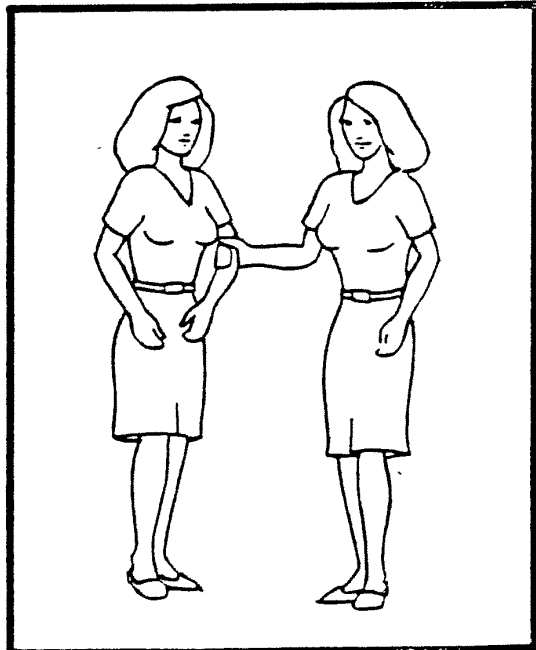

1

1

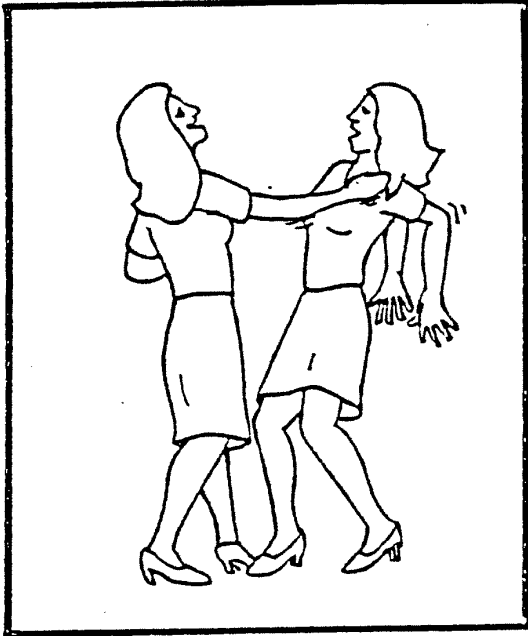

2

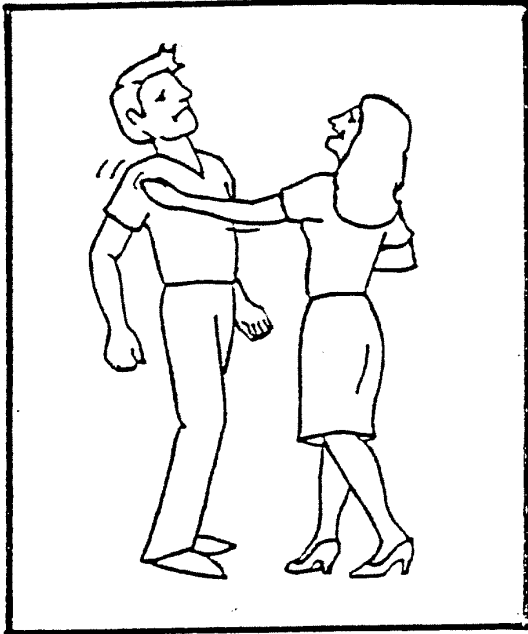

3

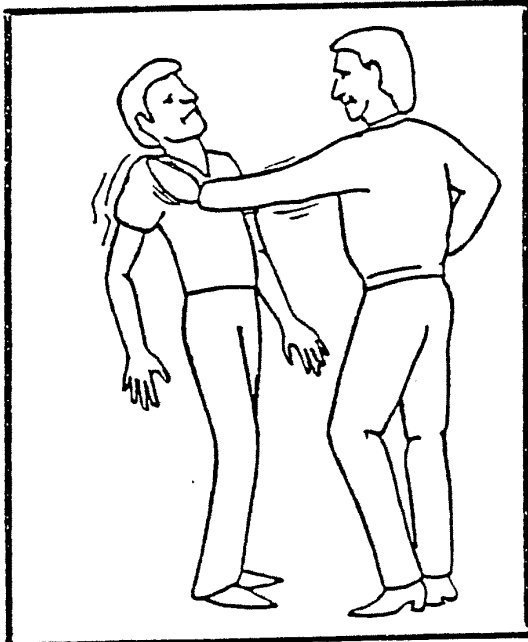

4

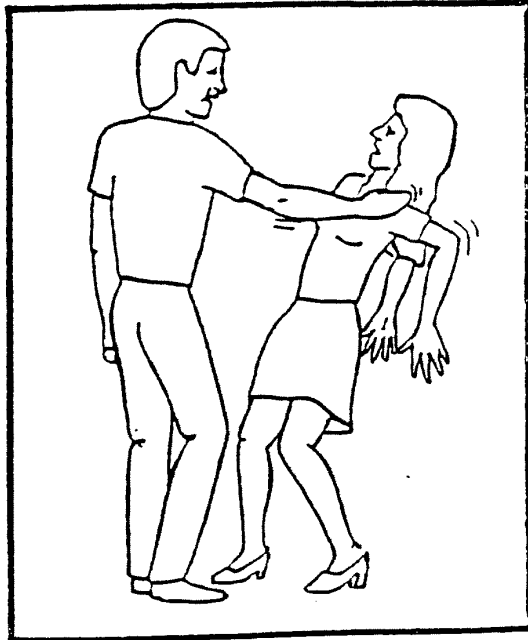

4

1

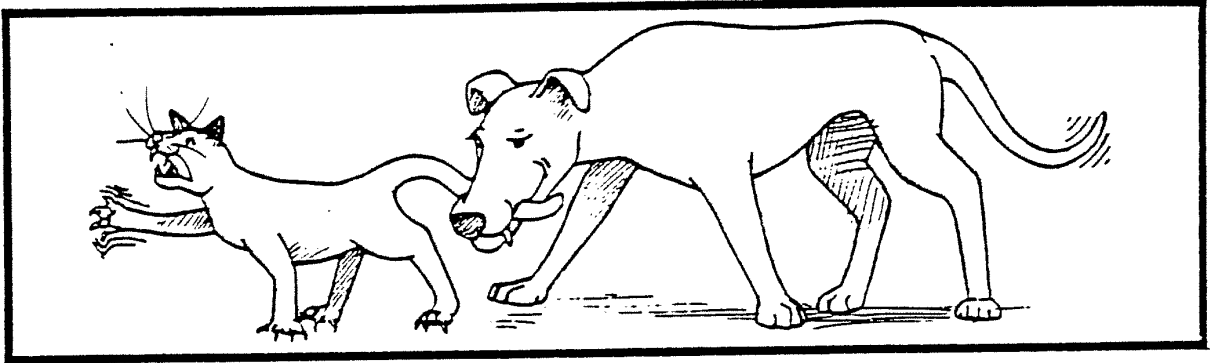

2

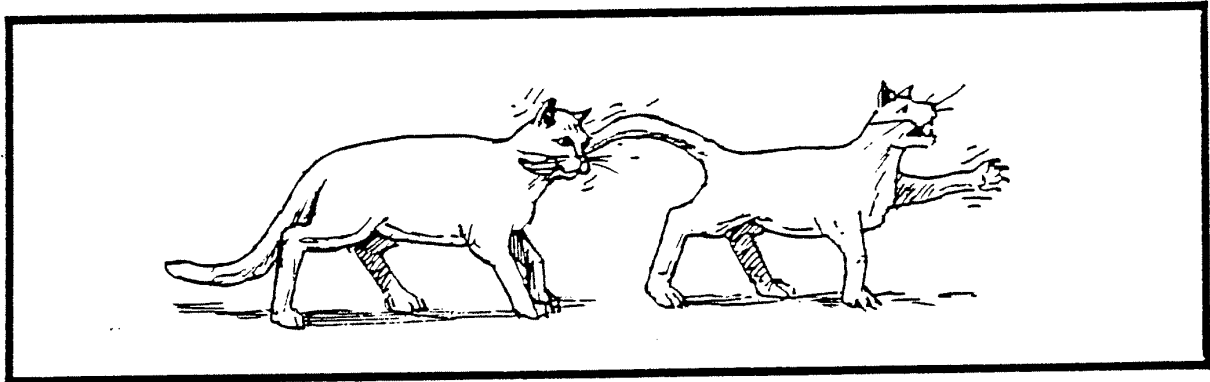

3

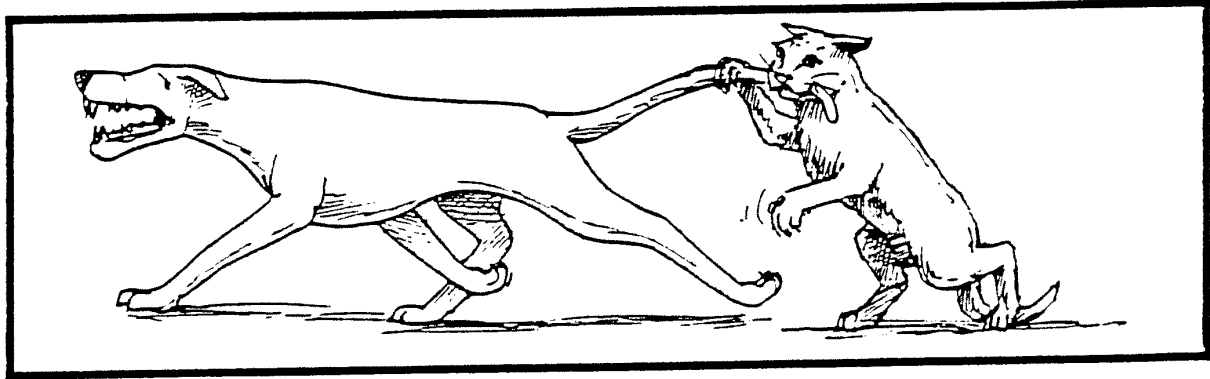

4

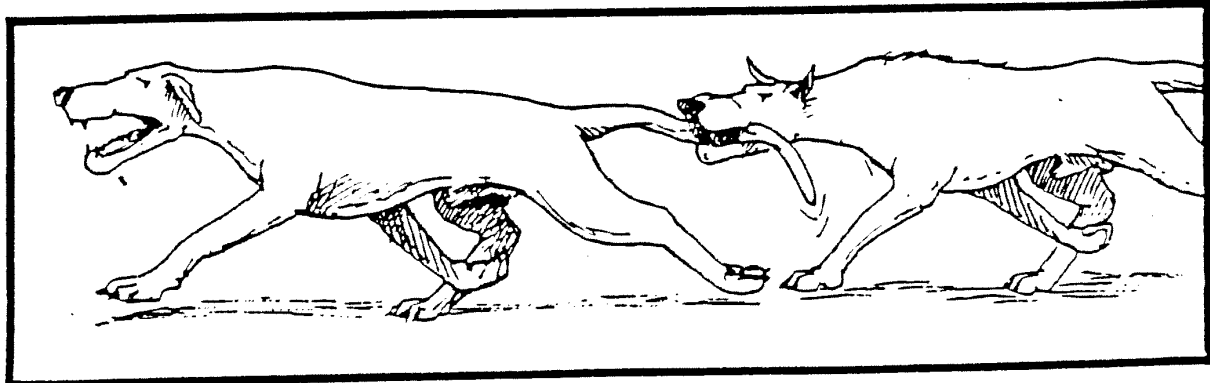

1

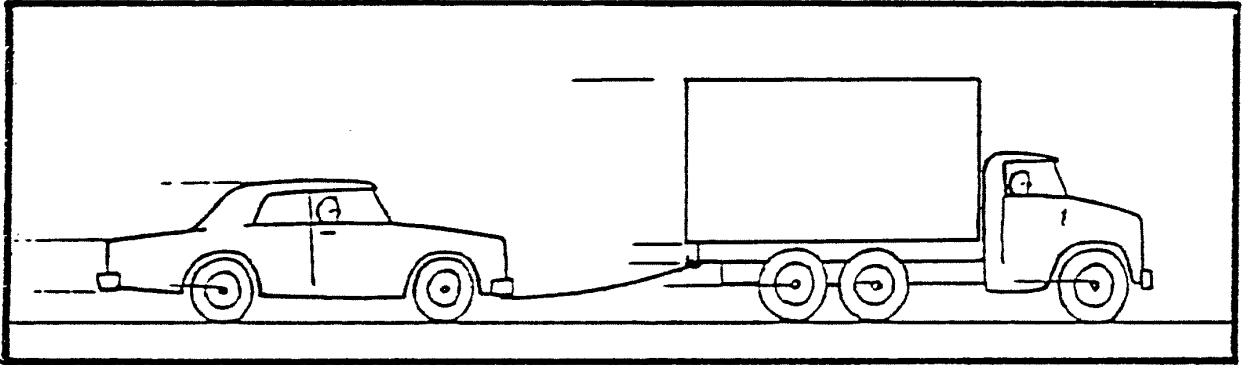

2

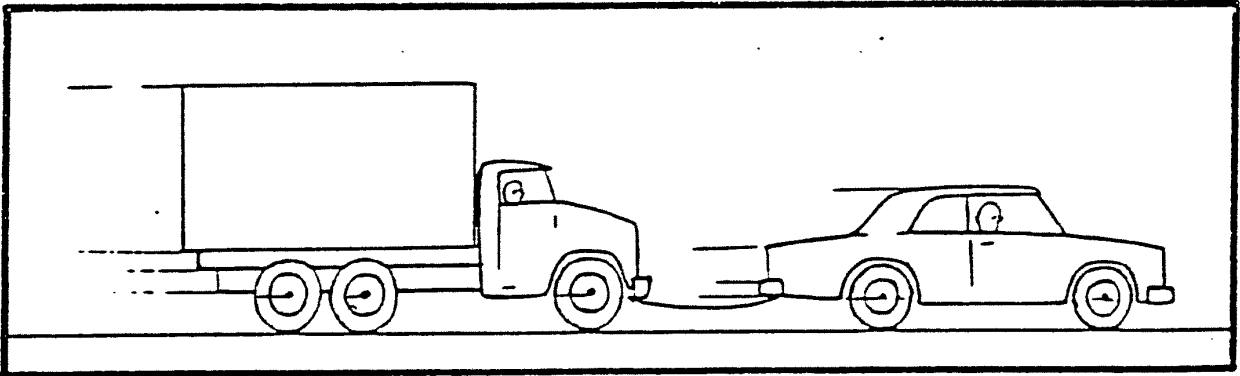

10



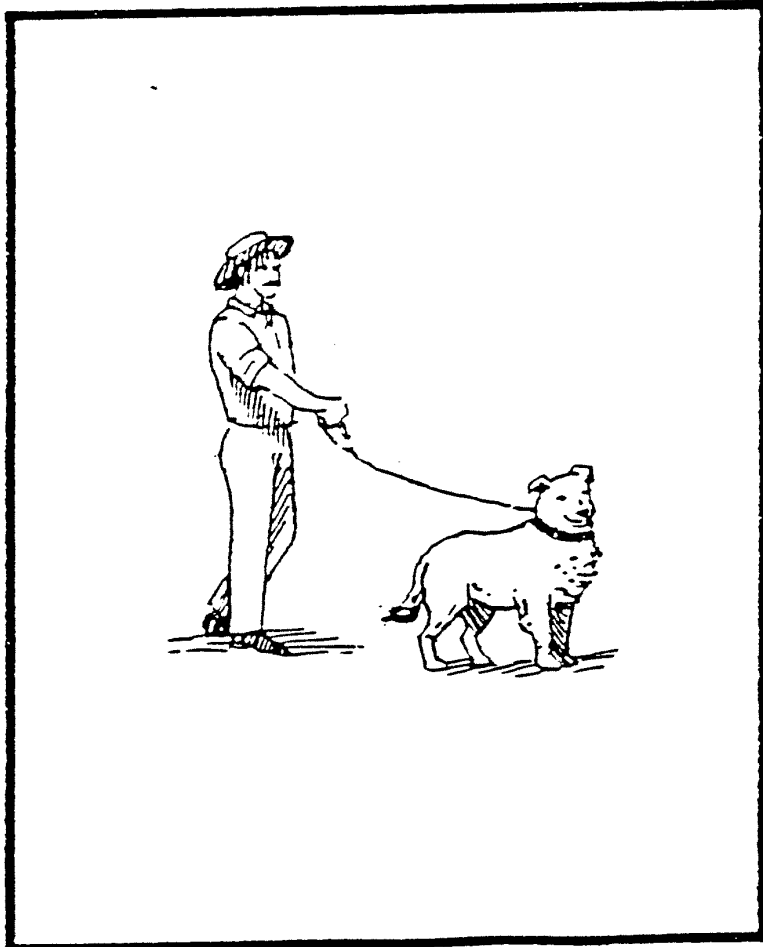

1

2

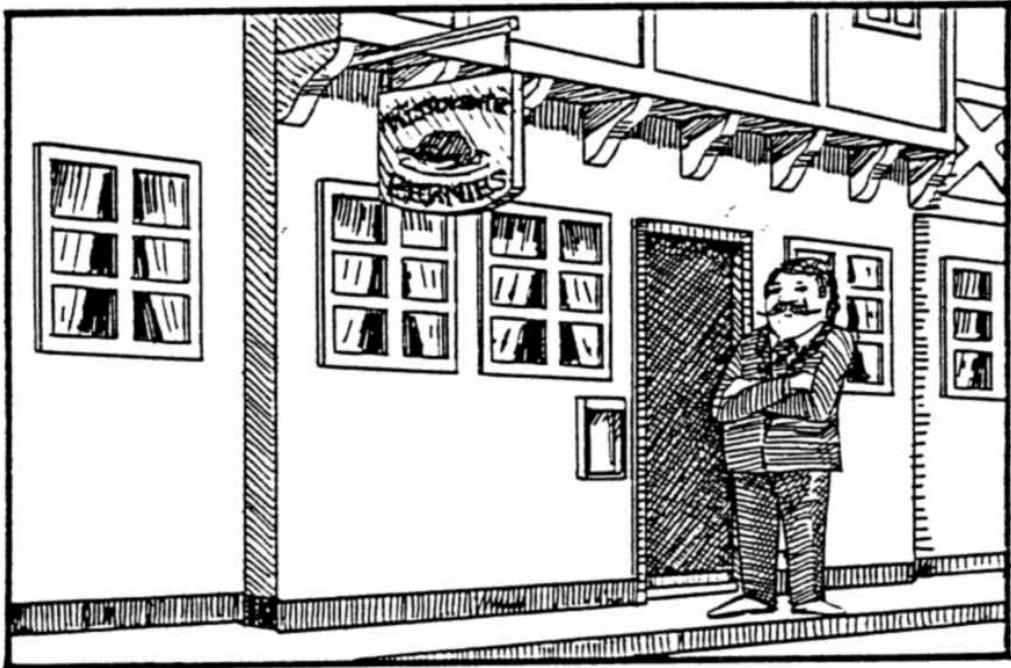

2

mier

roer

mus

luis

tand

De jongen houdt het meisje vast

Zij wast haar

De kat wordt door de hond gebeten

Het is de vrachtwagen die de auto aanrijdt

BEGRIPSVERMOGEN VOOR GESCHREVEN WOORDEN

mier

1

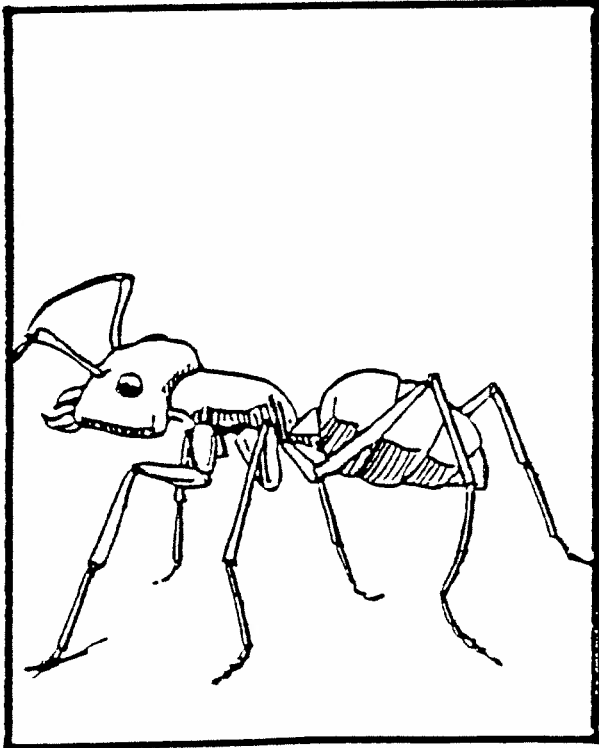

2

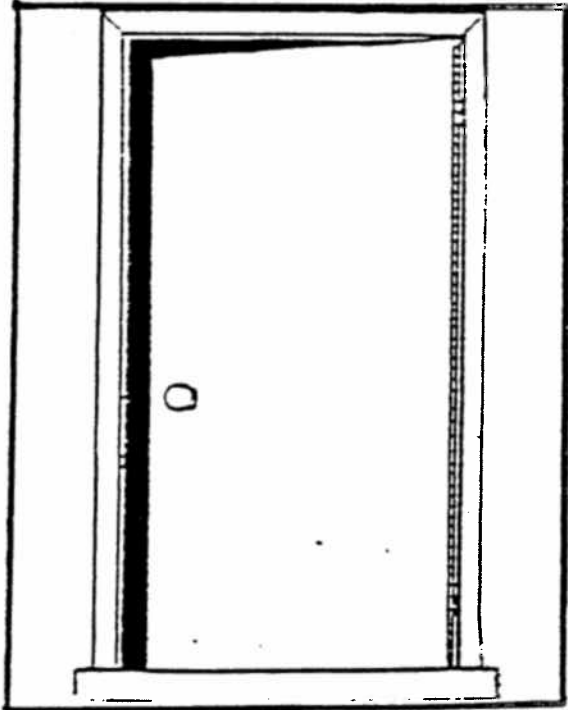

3

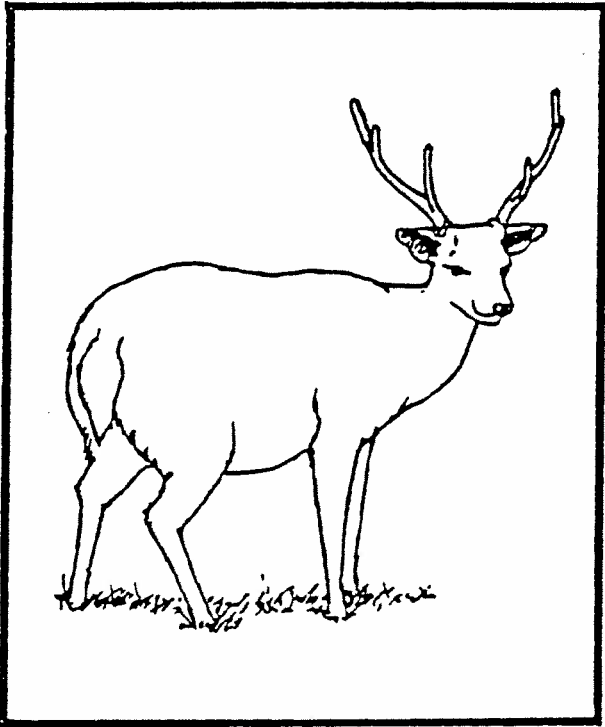

4

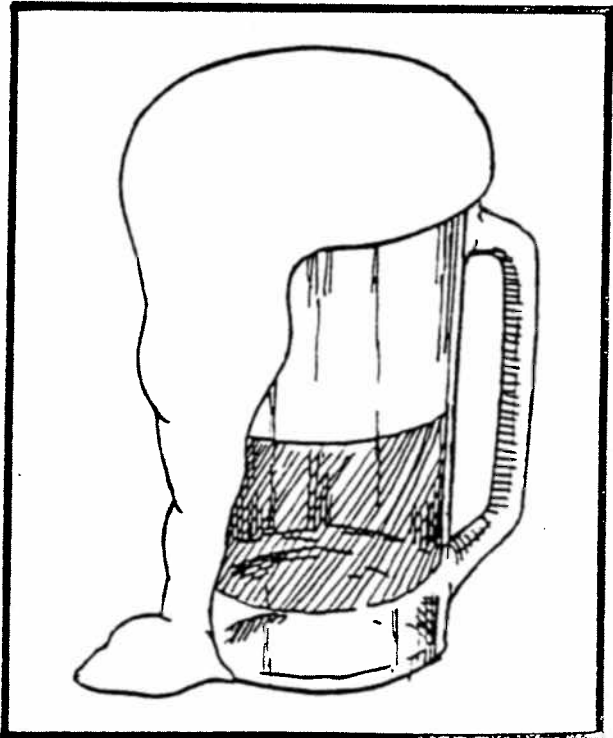

roer

1

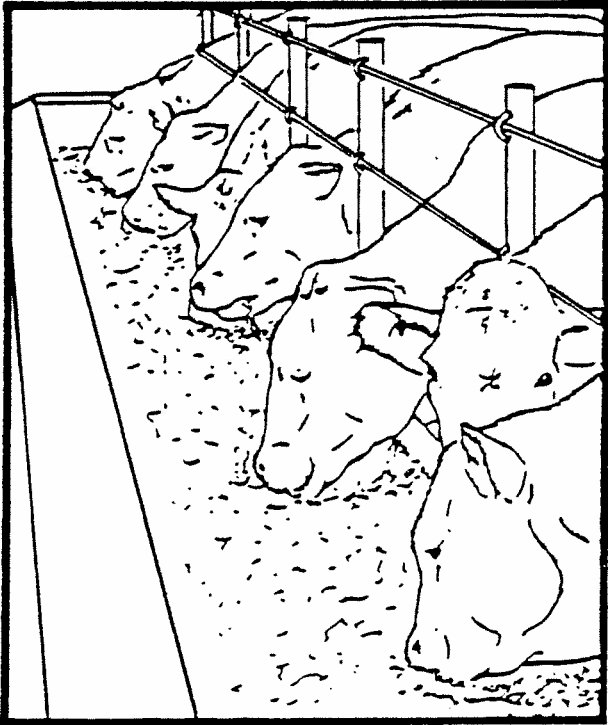

2

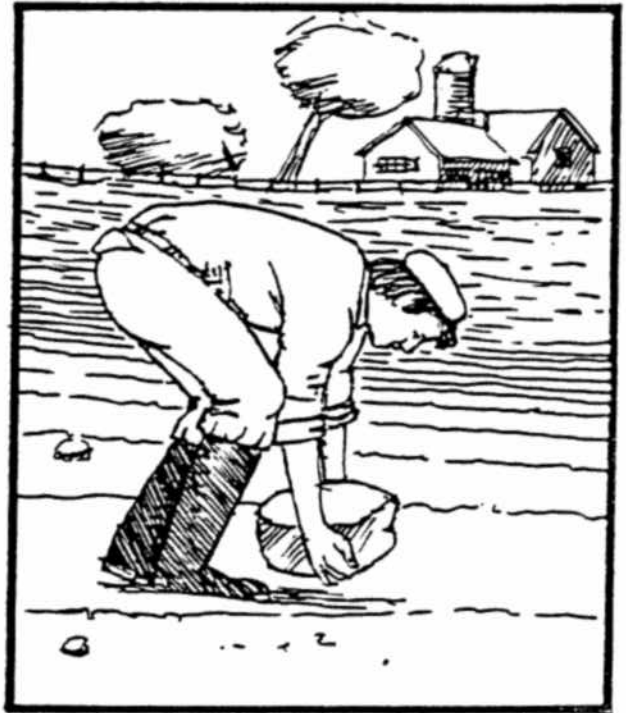

3

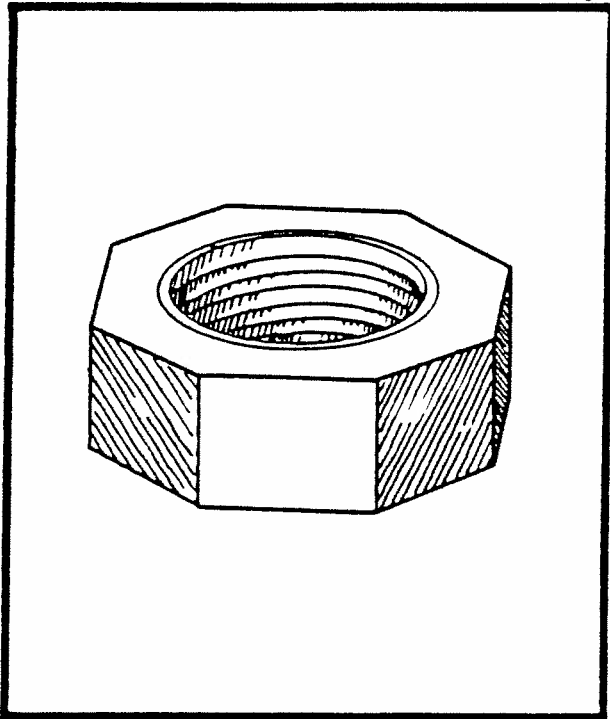

4

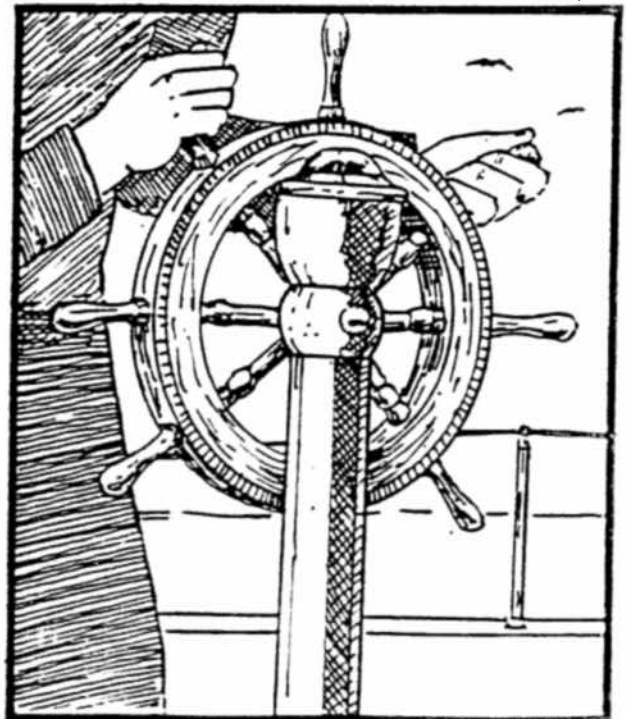

mus

1

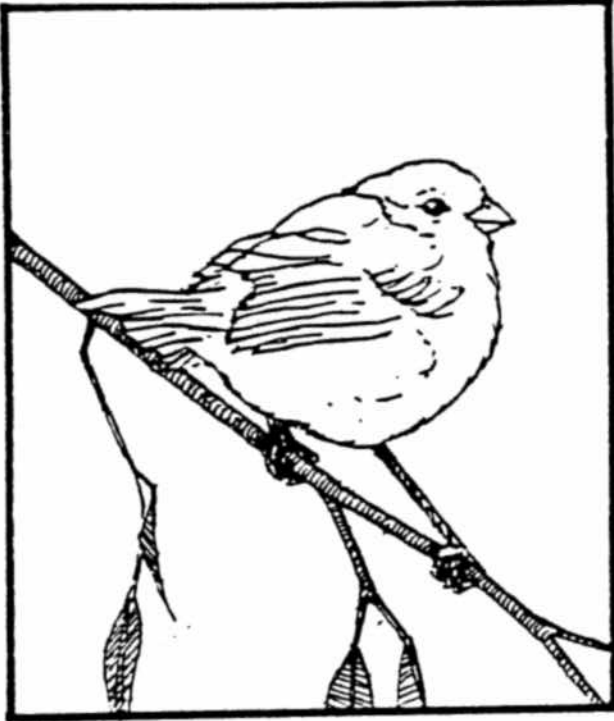

2

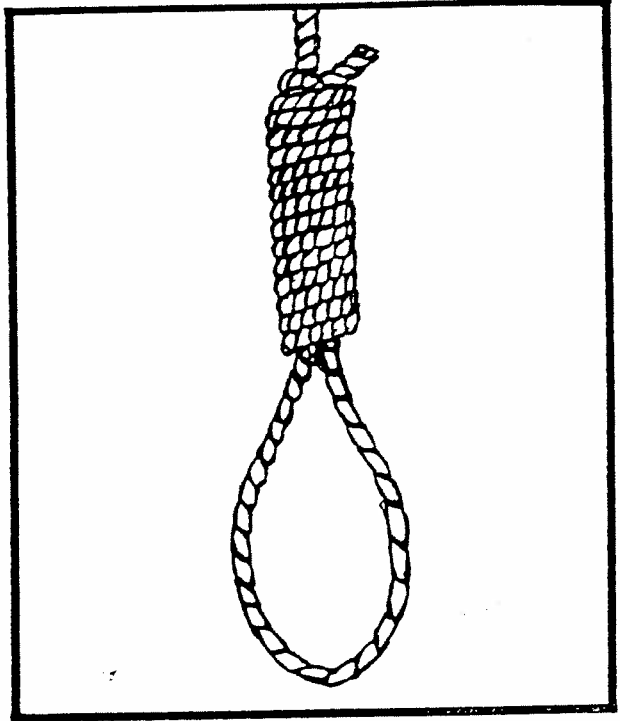

3



4

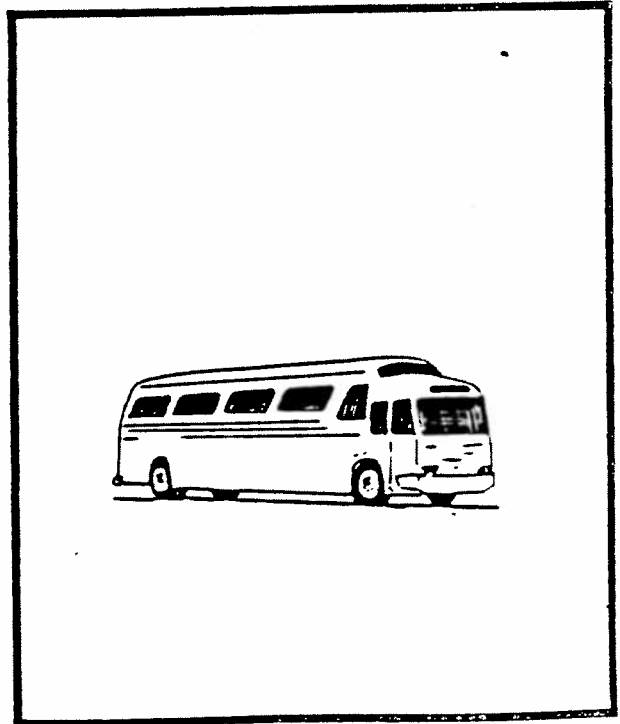

luis

1

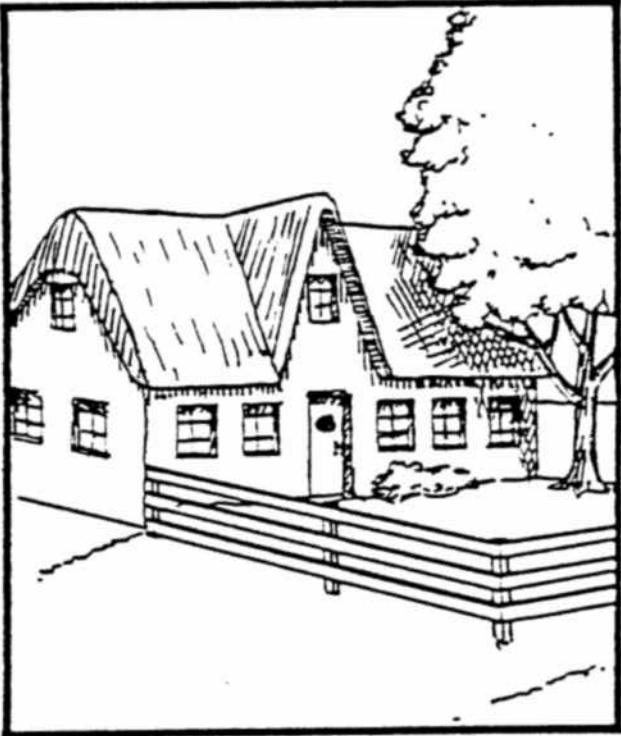

2

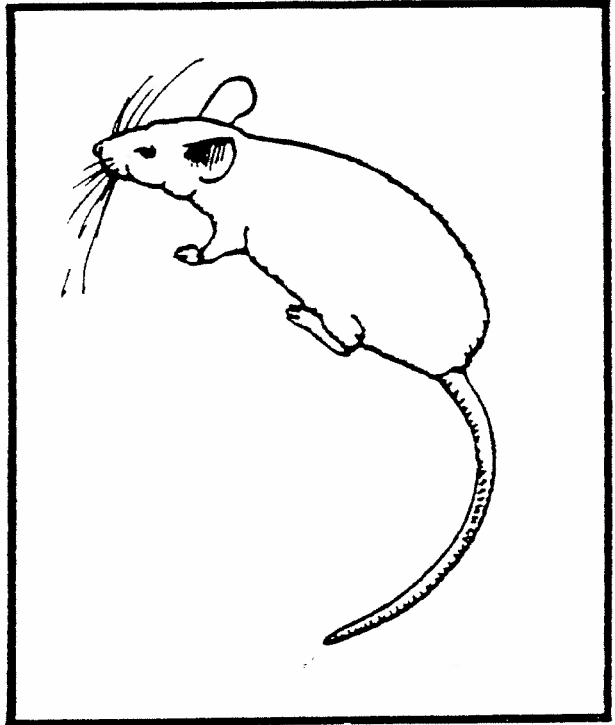

3

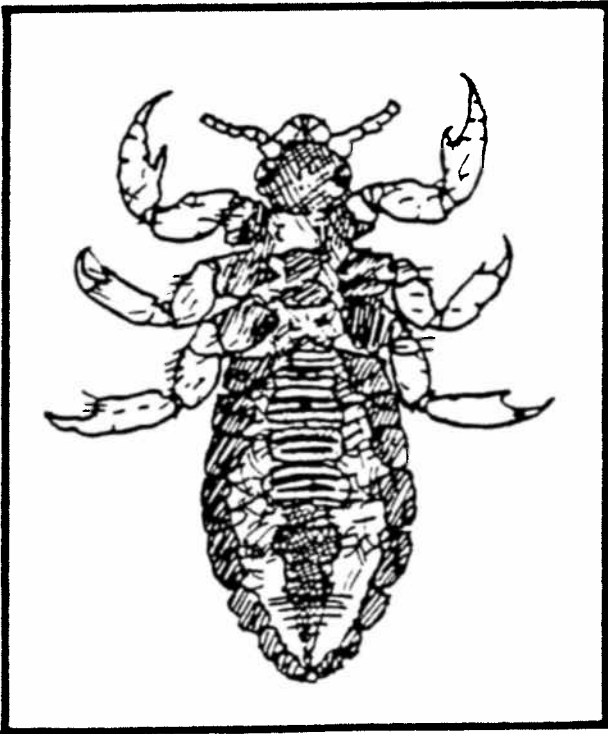

4

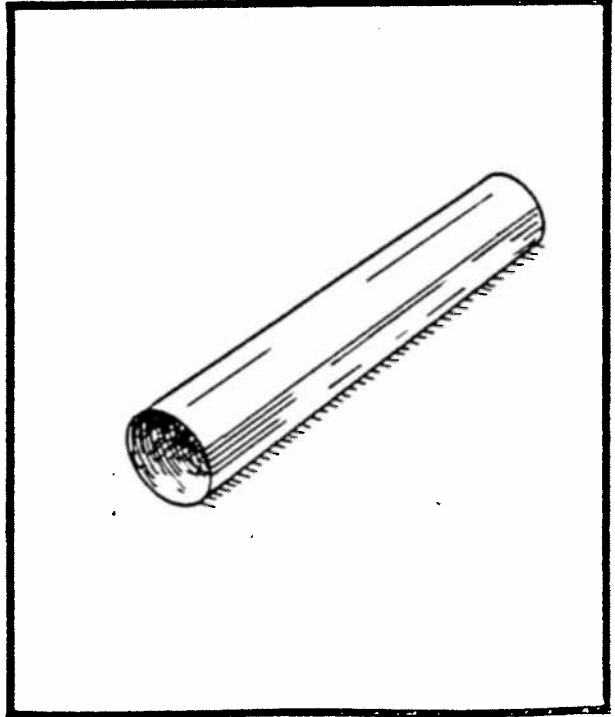

BEGRIPSVERMOGEN VOOR GESCHREVEN ZINNEN

De jongen houdt het meisje vast

1

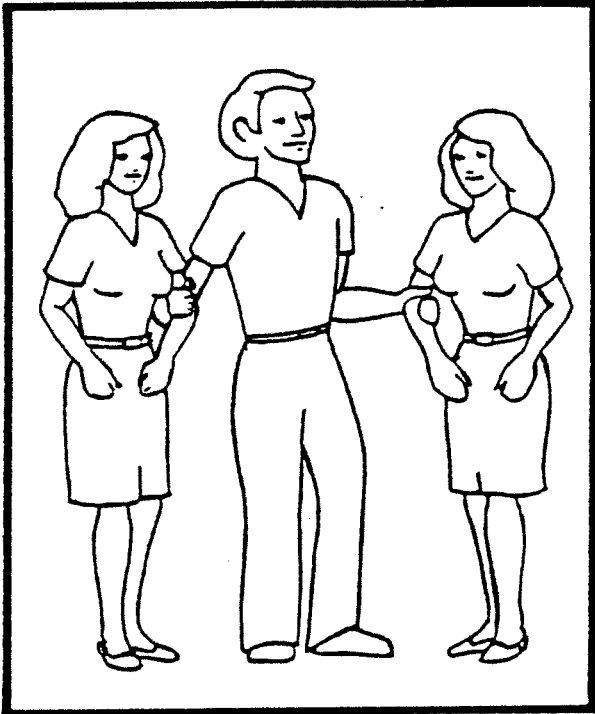

2

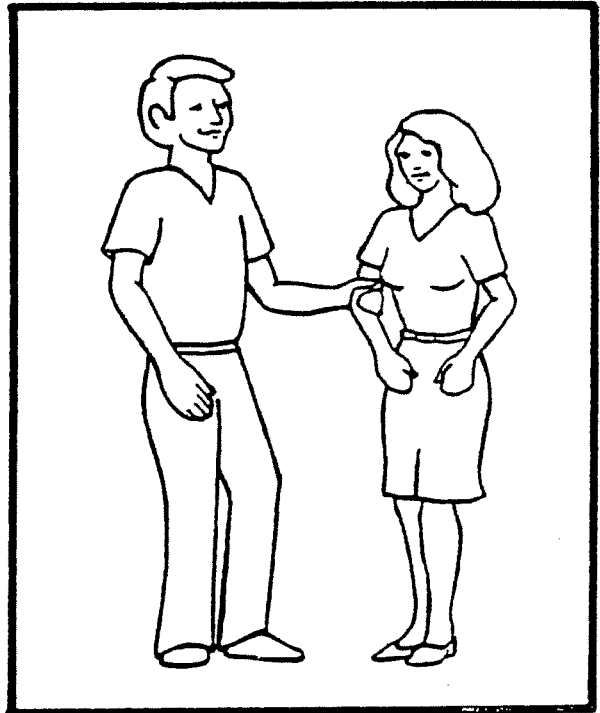

3

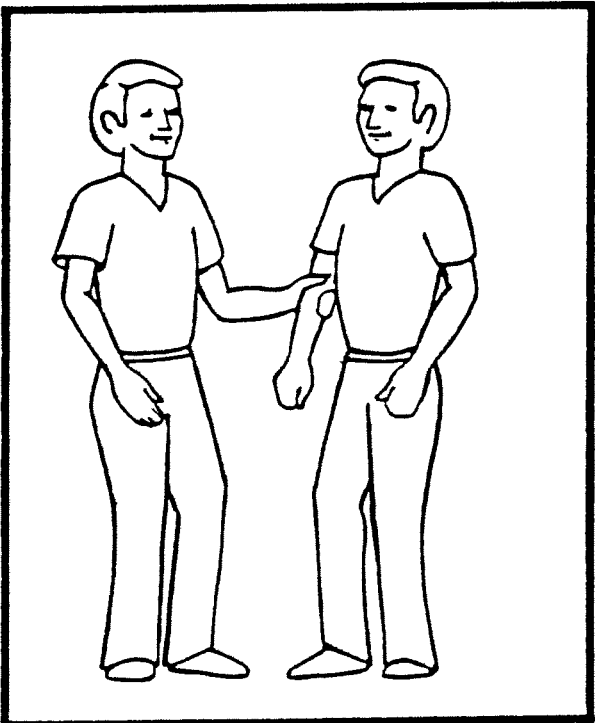

4

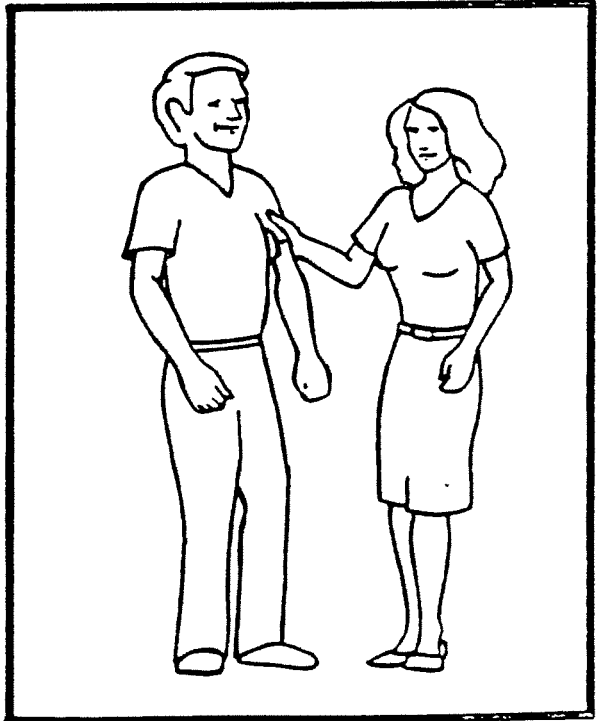

Hij wast zich zelf

1



2

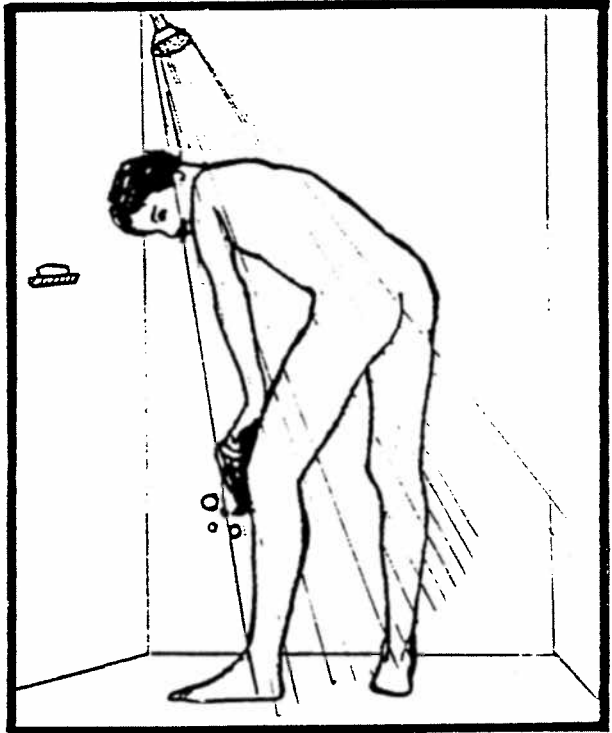

3

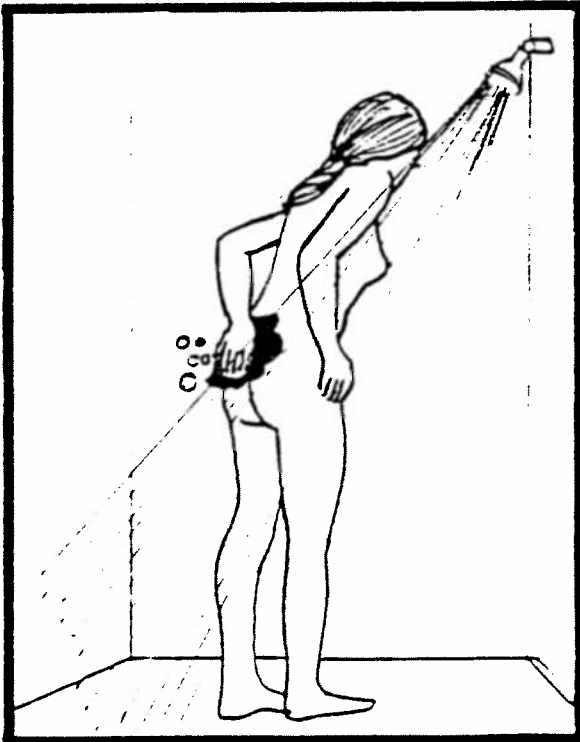

4



De hond wordt door de kat gebeten

1

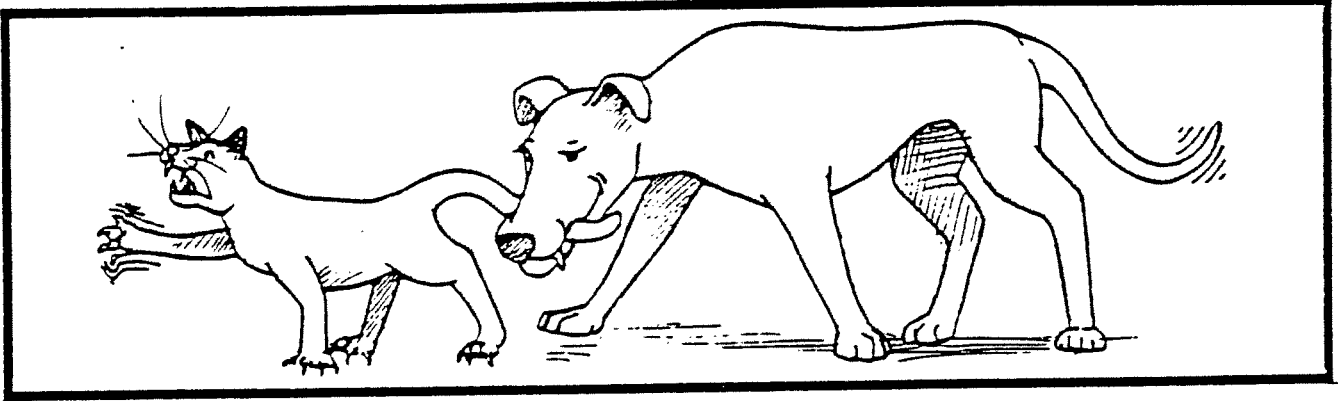

2

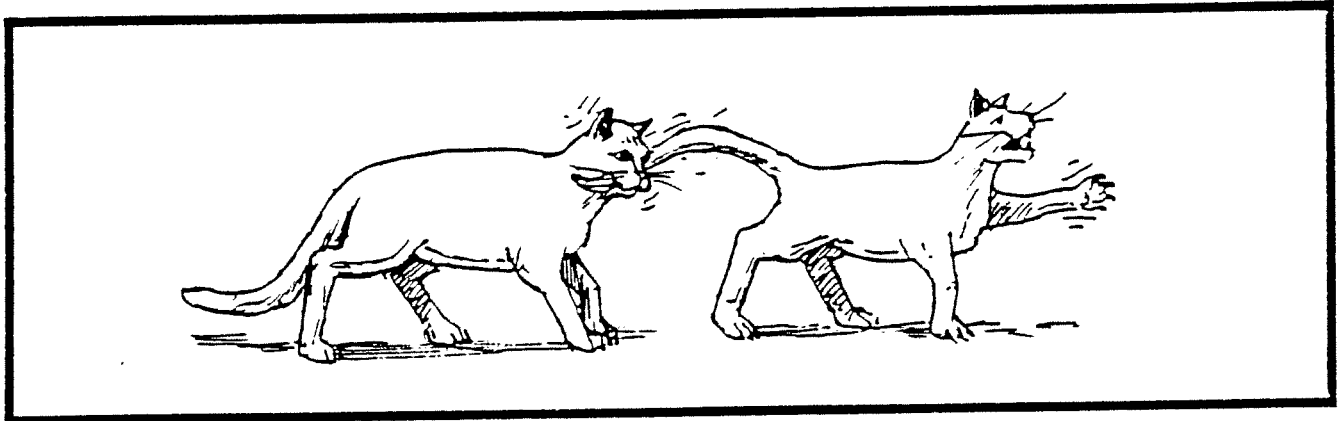

3

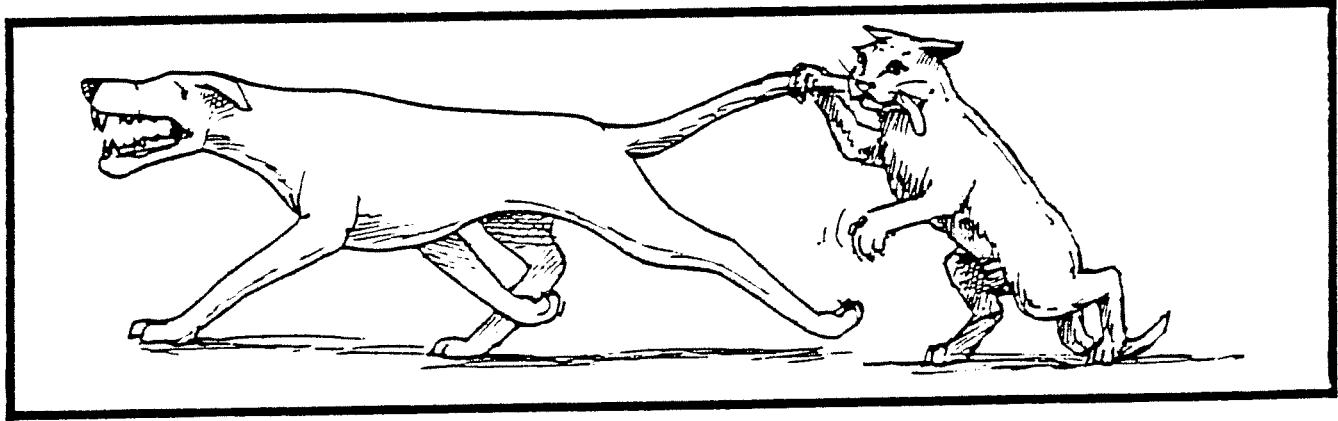

4

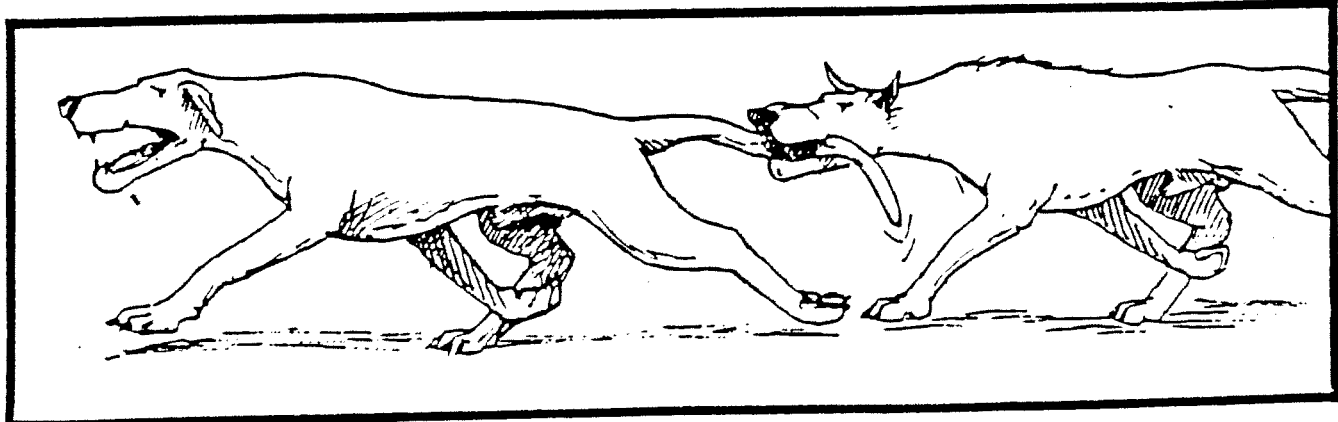

De vrachtwagen wordt niet door de auto gesleept

1

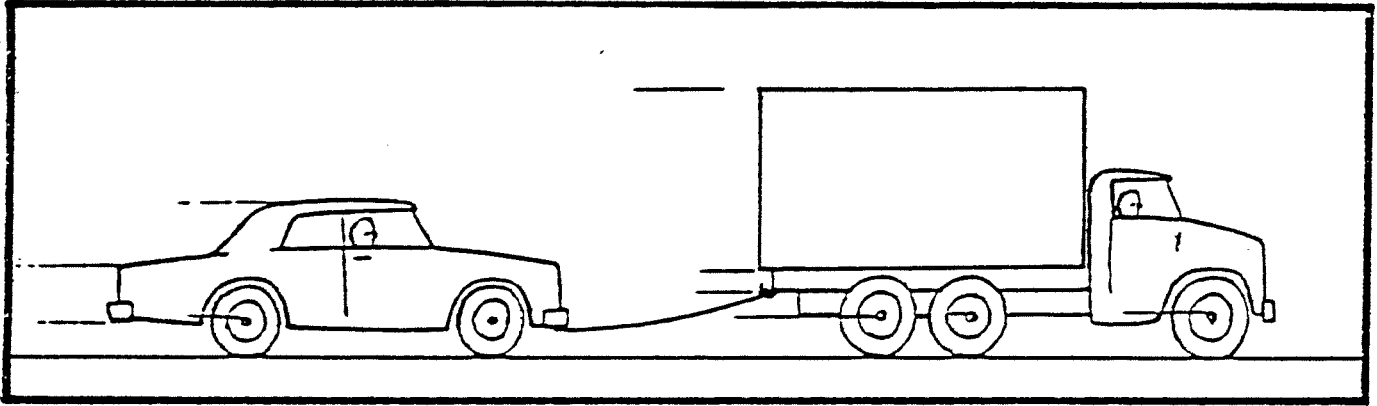

2

